

DISTRIBUTOR/AGENT	DATE OF ORDER
	DATE OF DELIVERY:
	NAME OF THE ADDRESSEE/USER:



FEATURES

- **More sizes in one frame**
- **Frame:** light and umbrella folding system, in aluminium. It is painted with non-toxic epoxy powders. When folded Trollino is compact and it allows you to carry it as if it was a travel trolley.
- **Push handles with manual and parking brakes.**
- Resistant and durable **backrest** guaranteed by the cross on the back. Reclinable on three positions and easily adjustable in height.
- Slightly tilted **seat**. It is easily adjustable in depth and width thanks to padded pelvic side supports (additional components 958). The cross below ensures stability, comfort and durability.
- Extremely breathable **upholstery** (not removable). It is resistant and easily washable. **Fire Retardant** according to *EN 1021-1:2014 and EN 1021-2:2014*.
- User manual **bag** and wrench on the back of the backrest.
- **Legrest** adjustable in height.
- Elevatable and swivel **footrests**, without encumbrance.
- **Solid wheels:** 17 cm (7 in) front swiveling wheels and 25 cm (10 in) rear wheels with **independent drum brakes**. **Overcoming step bar** on both rear wheels.



very breathable and fire retardant upholstery

Marked **CE**



Attention!
Read carefully the user and maintenance manual

Please check off the interested products



Unit of Measurement: cm (in); kg (lb)

Backrest colour: Seat colour: **Black** Frame colour: **Black**

- Red
- Pink
- Blue
- Black

MEASURES

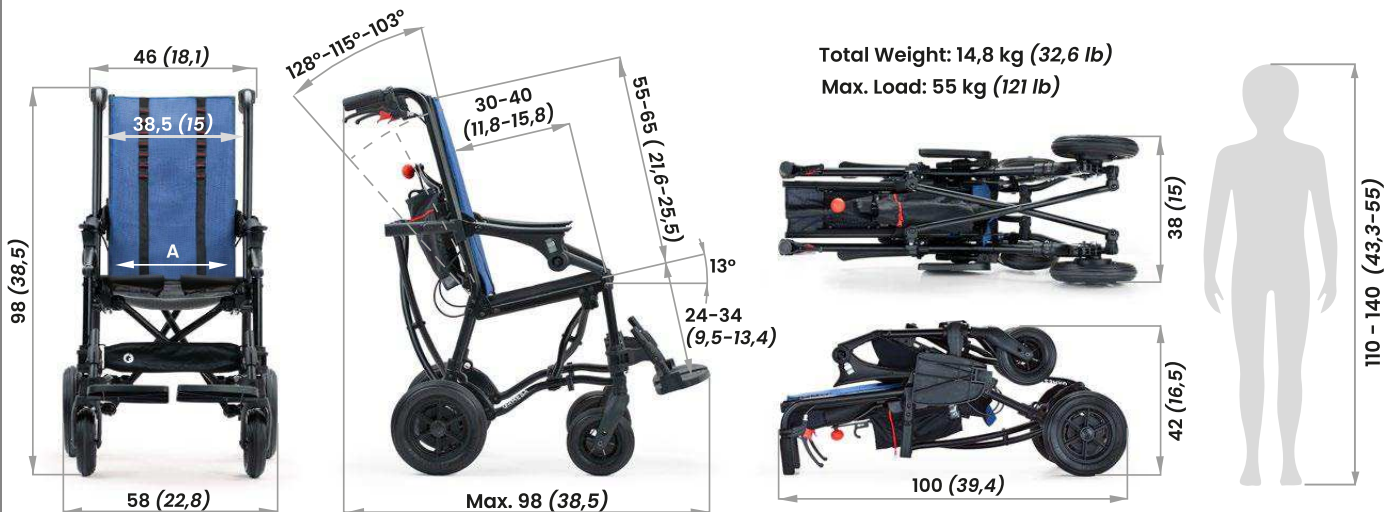

Total Weight: 14,8 kg (32,6 lb)
Max. Load: 55 kg (121 lb)

A: 36 cm (14 in). For different width (32 and 28 cm - 12,6 and 11 in) please select 958 padded pelvic side supports.

C
O
M
P
O
N
E
N
T
S

951 Height adjustable push handles. It increases the total height of max. 7 cm (2,7 in); 98 cm (38,5 in) with standard push handles, 98-105 cm (38,5-41,3 in) with 951 push handles.

COMPONENT TO BE ORDERED WITH THE PRODUCT



↙ COMPONENTS TO CHOOSE ALSO AFTERWARDS

835 Shaped and enveloping headrest adjustable in height.



865 Padded headrest adjustable in height.



838 Trunk side supports adjustable in height, width and rotation

mini S

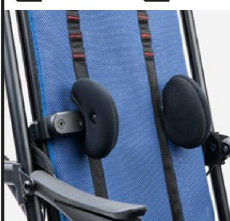

868 Wrappable and flexible trunk support, multiajustable in height, width and inclination

S

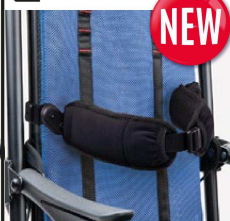

958 Padded pelvic side supports 32 cm (12,6 in) seat width

Extra Padding 28 cm (11 in) seat width



947 Pelvic belt with variable angle

S M

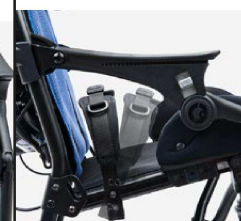

920 4 point pelvic belt

S M

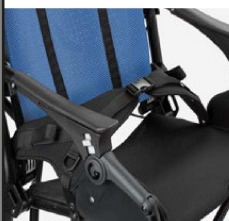

853 Vest harness

mini S

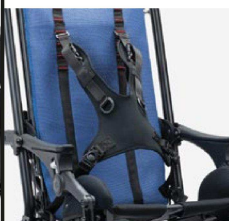

853 slim 4 point shaped harness

M

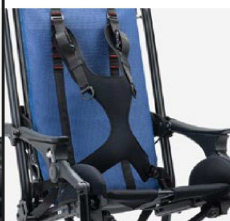

834N Padded and removable abduction block

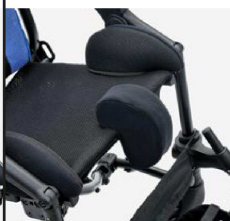

839 Front handlebar adjustable in tilt

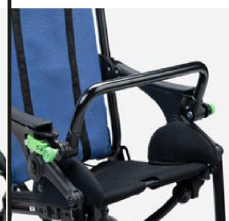

819 Elevating Canopy with bag and rear small window



825 Rain cover to fix on the 819 canopy

825B Back Protection Cloth



818 Thermic cover



960 Heel rests



956 Footrests adjustable in tilt



858 Shopping basket



812 Front wheel direction locks



844 Padded side protection covers

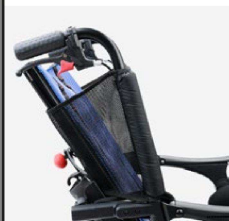

891 Set of 4 tie down hooks for the forward-facing transport of the pushchair in a motor vehicle.



Notes.....
.....
.....
.....
.....
.....



download and send the form to info@ormesa.com

COMPONENTS MEASURES

947



small
A=19 cm/7,4 in
B=6 cm/2,3 in

medium
A=25,5 cm/10 in
B=8 cm/3,1 in

920

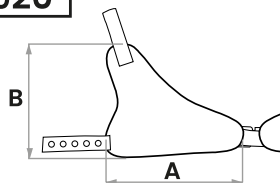

small
A=16 cm/6,2 in
B=15,5 cm/6,1 in

medium
A=23 cm/9 in
B=19 cm/7,4 in

838

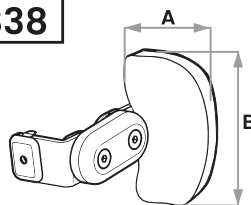

mini
A=9 cm/3,5 in
B=11 cm/4,3 in

small
A=10 cm/3,9 in
B=13 cm/5,1 in

C= 16-23 cm/6,2-9 in

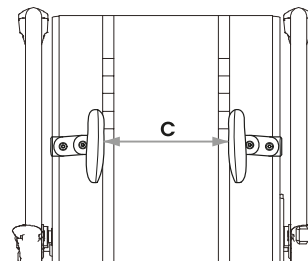

868

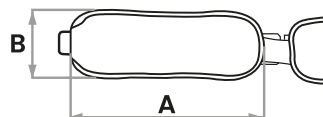

small
A=26 cm/10,2 in
B=9 cm/3,5 in

853

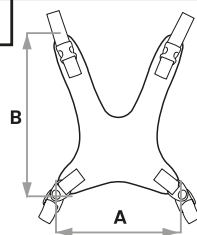

mini
A=20,5 cm/8 in
B=28 cm/11 in

small
A=25 cm/9,8 in
B=34 cm/13,3 in

853 slim

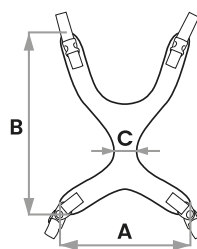

medium
A=33 cm/12,9 in
B=46 cm/18,1 in
C=5 cm/1,9 in

834N

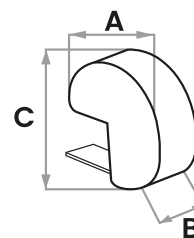

mini/s
A=12 cm/4,7 in
B=4 cm/1,5 in
C=14 cm/5,5 in

